

SECTION
D

PENCIL PARTS AND PRICES

<u>NAME</u>	<u>FACTORY SYMBOL</u>	<u>LIST PRICE</u>	<u>ASSEMBLED CAP</u>	<u>BARREL</u>	<u>MECHANISM</u>	<u>TIP</u>
Handyman Pencil	WE	1.95	1.00	.60	.40	.50
Chrome Cap-pencil	H195	1.95	1.00	.60	.40	.50
Brass Cap-pencil	H196	1.95	1.00	.60	.40	.50
Cadet (T.P.)	T20-X	3.00	1.50	1.00	1.25	.50
Craftsman (TP)	T2-X	4.00	1.75	1.00	1.25	.50
"500" Pencil	C11T8W	3.75	1.50	2.00	1.25	.50
"875" Pencil	C11TLOW	5.00	2.00	2.00	1.25	.75
Admiral and Saratoga (TP)	T7	6.00	2.25	2.00	1.25	.50
Sovereign (TP) (Sheaffer clip)	T61-X	5.25	2.00	2.00	1.25	.75
Sovereign (TP) (Plain clip)	T60-X	5.25	2.00	2.00	1.25	.75
Statesman and Valiant (TP)	T4	7.25	3.25	2.00	1.25	.75
Clipper and Sentinel (TP)	T6-X	7.50	4.50	2.00	1.25	.75
Signature (TP)	T4-6	10.00	7.50	2.00	1.25	.75
Autograph (TP)	T4-auto	17.50	12.50	2.00	1.25	2.50
Autograph (TP) (New)	C11T4A	12.50	8.50	2.00	1.25	.75
Triumph (TP) (Band on Barrel)	TY9B	15.00	6.00	6.00	1.25	.75
Triumph (TP) (Band on Cap)	TY9	15.00	6.00	6.00	1.25	.75
Crest (TP)	T6	9.00	6.00	2.00	1.25	.75
Masterpiece (TP)	TZ	65.00	30.00	28.00	1.25	2.50
Sheaffer Utility Pencil	TE-X	1.95	1.00	1.00	1.25	.50
Lady Sheaffer	I-VI	4.95	2.00	2.00	1.25	.75
Lady Sheaffer	X-XIV	5.00	2.00	2.00	1.25	.75
Lady Sheaffer	XV-XXI	7.50	4.00	2.50	1.25	.75
Lady Sheaffer	XXXV	10.00	5.00	3.50	1.25	.75
"PEP" Pencil	CF10&CF12F	2.00	1.00	.50	.40	.50
Desk Pencil (TP)	D4	5.00	3.25	1.00	1.25	.75
			(quill & barrel)	(Gripping Section)		
<u>OLDER LINES</u>						
Craftsman	H3	3.00	1.50	1.00	1.00	.50
Admiral	H5	3.75	1.75	1.00	1.00	.50
Statesman	H7	4.00	1.85	1.00	1.00	.75
Tuckaway	M7	4.00	1.85	1.00	1.00	.75
Statesman and Valiant TM	H40	5.00	2.75	1.00	1.00	.75
Sentinel Deluxe	H6XC	5.00	2.85	1.00	1.25	.75
Sentinel Deluxe Tuckaway	M6XC	5.00	2.85	1.00	1.25	.75
Crest Deluxe	H6	7.50	4.85	1.00	1.25	.75
Crest Deluxe Tuckaway	M6	6.00	3.85	1.00	1.25	.75
Signature	H40-6	10.00	7.00	1.00	1.25	.75
Autograph	H4-auto	15.00	10.50	1.00	1.25	2.50
Autograph Tuckaway	M4-auto	15.00	10.50	1.00	1.25	2.50
Triumph (Metal)	Y9B	12.50	6.00	6.00	1.25	.75
Desk Pencil	LD6	6.50	3.90	1.00	1.25	.75
			(quill & barrel)	(Gripping Section)		

NOTE: FOR PENCIL PARTS EXCHANGE PRICES PLEASE SEE PAGE D13

8/1/62

D1

PENCIL PARTS AND PRICES

<u>NAME</u>	<u>FACTORY SYMBOL</u>	<u>LIST PRICE</u>	<u>CAP</u>	<u>CAP SHELL</u>	<u>CLIP</u>	<u>CLIP SPRING</u>	<u>CAP LINER</u>	<u>BAND</u>	<u>WHITE DOT</u>	<u>ORNAMENT</u>	<u>BARREL</u>	<u>MECHANISM</u>	<u>TIP</u>
Gold Pep Pencil	CFY	\$2.95	\$1.50	None	--	None	--	None	None	None	\$.50	\$1.00	\$.50
White Dot Pencil III	CM9Y	7.50	3.25	1.80	1.25	.20	.50	None	.10	--	2.50	1.25	.75
Compact I Pencil	CC4-X	3.95	1.50	1.25	.75	.20	None	.30	None	None	1.00	1.25	.50
Compact II Pencil	CC4	4.95	2.20	1.25	1.00	.20	None	.35	.10	None	1.00	1.25	.75
IMPERIAL III or TARGET	CM3	4.00	2.00	None	--	None	None	--	None	None	1.00	1.25	.50
PFM I Pencil	CMX	4.95	2.75	1.25	1.00	.20	None	.30	None	None	1.00	1.25	.50
PFM II Pencil	CMW	5.00	2.75	--	1.25	.20	.50	None	.10	None	1.00	1.25	.50
PFM III or IMPERIAL IV Pencil	CM	5.00	2.75	1.25	1.25	.20	None	.35	.10	None	1.00	1.25	.75
PFM IV or IMPERIAL VI Pencil	CMWN	7.50	5.00	--	1.25	.20	.50	.50	.10	None	1.00	1.25	.75
PFM V Pencil	CMG	10.00	7.00	--	1.25	.20	.50	None	.10	None	1.00	1.25	.75
PFM Autograph	CMA	12.50	8.50	1.25	1.25	.20	None	5.80	.10	None	1.00	1.25	.75
500 Series Pencil	CM3W	3.95	1.75	--	.75	--	.25	--	--	--	1.00	1.00	.50
800 Series Pencil	CM3N	5.00	2.75	--	1.25	.20	None	.50	None	--	1.00	1.00	.50
1000 Series Pencil	CM6Y	6.00	3.75	--	1.25	.20	.25	--	--	--	2.00	1.00	.50

NOTE: FOR PENCIL PARTS EXCHANGE PRICES, PLEASE SEE PAGE DL3.

BALLPOINT PARTS AND PRICES

NAME	FACTORY SYMBOL	LIST PRICE	CAP	CLIP	CLIP SPRING	BAND & SLEEVE	BARREL	GRIPPING SECTION	FRICITION RING	UNIT	WHITE DOT	BARREL SPRING
<u>SLIP CAP MODELS</u>												
Smoothie	152-B	\$1.75	.50	None	None	None	\$.50	\$.50	\$.10	\$	None	None
Admiral or Saratoga	R6T	5.00	2.75	1.00	.20	.75	1.00	.75	.10	.79	None	None
Sovereign	R3TX	5.00	2.75	1.50	.20	None	1.00	.75	.10	.79	None	None
	R3LTX											
Statesman or Valiant	R4T	6.00	3.75	1.50	.20	1.75	1.00	.75	.10	.79	.10	None
Clipper or Sentinel	R9T-X	7.50	4.50	1.50	.20	.75	1.00	.75	.10	.79	.10	None
Crest	R9T	9.00	6.00	1.50	.20	None	1.00	.75	.10	.79	.10	None
Signature	R4T-6	10.00	8.50	1.50	.20	7.00	1.00	.75	.10	.79	.10	None
Autograph	R4T Auto	17.50	13.00	6.00	.20	7.00	1.00	.75	.10	.79	.10	None

SLIDE CAP RETRACTABLE MODELS

White Dot Stainless	B15CY	10.00	5.00	--	None	None	4.25	None	None	.79	.10	.05
White Dot Gold Filled	B14CY	15.00	7.50	--	None	None	6.75	None	None	.79	.10	.05

8/1/62

NAME	FACTORY SYMBOL	LIST PRICE	CAP	SLIDE SPRING	MECHANISM SLIDING SPRING	SLIDE COLLAR MECH.	SLIDE COLLAR MECH.	PUSH BUTTON	TIP AND BARREL ASSEMBLY	UNIT
Brass Cap Utility	SL96	\$ 1.95	\$1.00	None	None	\$.50	\$.50	\$.05	\$.50	\$.79
Chrome Cap Utility	SL95	1.95	1.00	None	None	.50	.50	.05	.50	.79
Plastic Cap Retractable	B	1.95	1.00	None	None	.50	.50	.05	.50	.79
Valiant	SL4	2.95	1.75	None	None	.50	.50	.05	.75	.79
Sentinel	SL6-X	3.95	2.75	None	None	.50	.50	.05	.75	.79
Crest	SL6	7.50	6.00	None	None	.50	.50	.05	.75	.79
Signature	SL4-6	10.00	8.50	None	None	.50	.50	.05	.75	.79
All Metal Anodized	SBR	2.95	1.50	None	None	.50	.50	.05	.75	.79
\$1.95 Skripwriter	BHI	1.95	1.00	.20	.05	None	None	None	.50	.79
\$2.49 Skripwriter	BHW	2.49	1.25	.20	.05	None	None	None	.50	.79
\$1.49 Ballpoint	BHX	1.49	.70	.20	.05	None	None	None	.30	.79
Chrome Pep Ballpoint	HRFI	1.95	1.00	None	None	.50	.50	.05	.50	.79
\$1.95 Ballpoint	HRI	1.95	1.00	None	None	.50	.50	.05	.50	.79

PUSH BUTTON RETRACTABLE MODELS

Brass Cap Utility	SL96	\$ 1.95	\$1.00	None	None	\$.50	\$.50	\$.05	\$.50	\$.79
Chrome Cap Utility	SL95	1.95	1.00	None	None	.50	.50	.05	.50	.79
Plastic Cap Retractable	B	1.95	1.00	None	None	.50	.50	.05	.50	.79
Valiant	SL4	2.95	1.75	None	None	.50	.50	.05	.75	.79
Sentinel	SL6-X	3.95	2.75	None	None	.50	.50	.05	.75	.79
Crest	SL6	7.50	6.00	None	None	.50	.50	.05	.75	.79
Signature	SL4-6	10.00	8.50	None	None	.50	.50	.05	.75	.79
All Metal Anodized	SBR	2.95	1.50	None	None	.50	.50	.05	.75	.79
\$1.95 Skripwriter	BHI	1.95	1.00	.20	.05	None	None	None	.50	.79
\$2.49 Skripwriter	BHW	2.49	1.25	.20	.05	None	None	None	.50	.79
\$1.49 Ballpoint	BHX	1.49	.70	.20	.05	None	None	None	.30	.79
Chrome Pep Ballpoint	HRFI	1.95	1.00	None	None	.50	.50	.05	.50	.79
\$1.95 Ballpoint	HRI	1.95	1.00	None	None	.50	.50	.05	.50	.79

PROCEDURES FOR REPAIR: Slide Collar Mechanism, Page D8; All Metal, Page C14; Slide Spring Mechanism, Page C19.
 NOTE: FOR BALLPOINT EXCHANGE PRICES SEE PAGE D13.

BALLPOINT PARTS AND PRICES

NAME	FACTORY SYMBOL	LIST PRICE	CAP		CLIP SPRING	CAM	INNER SLEEVE	BAND	WHITE DOT		TIP AND BARREL ASSEMBLY		UNIT
			SHELL	CLIP					BARREL SPRING	BARREL ASSEMBLY			
<u>REMINDER CLIP MODELS</u>													
\$1.95 Reminder Clip	BJ4I	1.95	.25	.25	.10	.10	.30	None	None	None	.40	.05	.79
Gold Pep Ballpoint	BJ4Y	3.95	.50	1.25	.10	.10	.30	None	None	None	.40	.05	.79
\$2.95 Reminder Clip	BJ3W	2.95	.50	.75	.10	.10	.30	None	None	None	.40	.05	.79
White Dot Reminder Clip	BJ3	3.95	.50	1.50	.10	.10	.05	.35	.10	.10	.40	.05	.79
White Dot Ballpoint III	BJ7Y	7.50	2.75	1.50	.10	.10	.30	None	.10	.10	2.50	.05	.79
\$1.95 Reminder, PEP II	BJ4I-2	1.95	.25	.25	.10	.10	.30	None	None	None	.40	.05	.79
<u>SPINNER-RATCHET MODELS</u>													
\$1.00 Spinner	BPO-X	1.00	None	None	None	None	None	None	None	None	.25	.05	.79
\$1.00 Spinner	BPI	1.00	None	None	None	None	None	None	None	None	.25	.05	.79

GRIPPING SECTION & THREAD RING

NAME	FACTORY SYMBOL	LIST PRICE	GRIPPING SECTION		THREAD RING		QUILL	BARREL & QUILL BAND		BARREL SPRING	WHITE DOT		UNIT
			SECTION	THREAD RING	SECTION	THREAD RING		QUILL	BAND		BARREL SPRING	WHITE DOT	
<u>DESK BALLPOINT MODELS</u>													
Desk Ballpoint	DS195												
Black		\$1.95	\$.60	None	None	None	.60	None	\$.25	None	None	None	\$.79
Colored		2.45	.85	None	None	.85		None	.25	None	None	None	.79
White Dot Desk Ballpoint	S4TD	5.00	1.25	.50	1.75	None	None	3.25	None	.05	.10		.79

PROCEDURES FOR REPAIR: Reminder Clip Ballpoints, Page C23.

NOTE: FOR BALLPOINT EXCHANGE PRICES, SEE PAGE D13.

POSITIONING TOOL FOR COMPRESSION GASKET

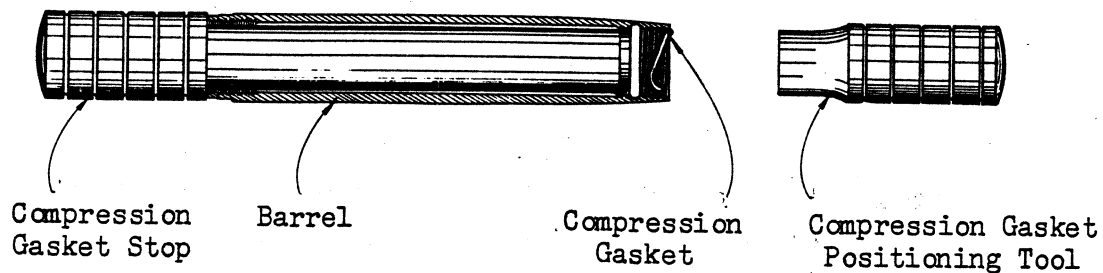

INSTRUCTIONS FOR USING COMPRESSION GASKET POSITIONING TOOLS

Three sizes: Thin Model, Regular & Snorkel

1. Dismantle barrel. Refer to disassembly instructions. Section C
2. Insert compression gasket stop tool in trunnion end of barrel (the end that has the metal ferrule) as far as it will go.
3. Start compression gasket into opposite end of barrel.
4. Use compression gasket positioning tool, and push and rotate tool to position gasket in recess.
5. Check gasket after removing positioning tool to be sure it is in recess.

CONVENTIONAL POINT & FEED PUSHING TOOL
PRICE \$ 2.25 EACH - NET
(WITHOUT PLIERS)

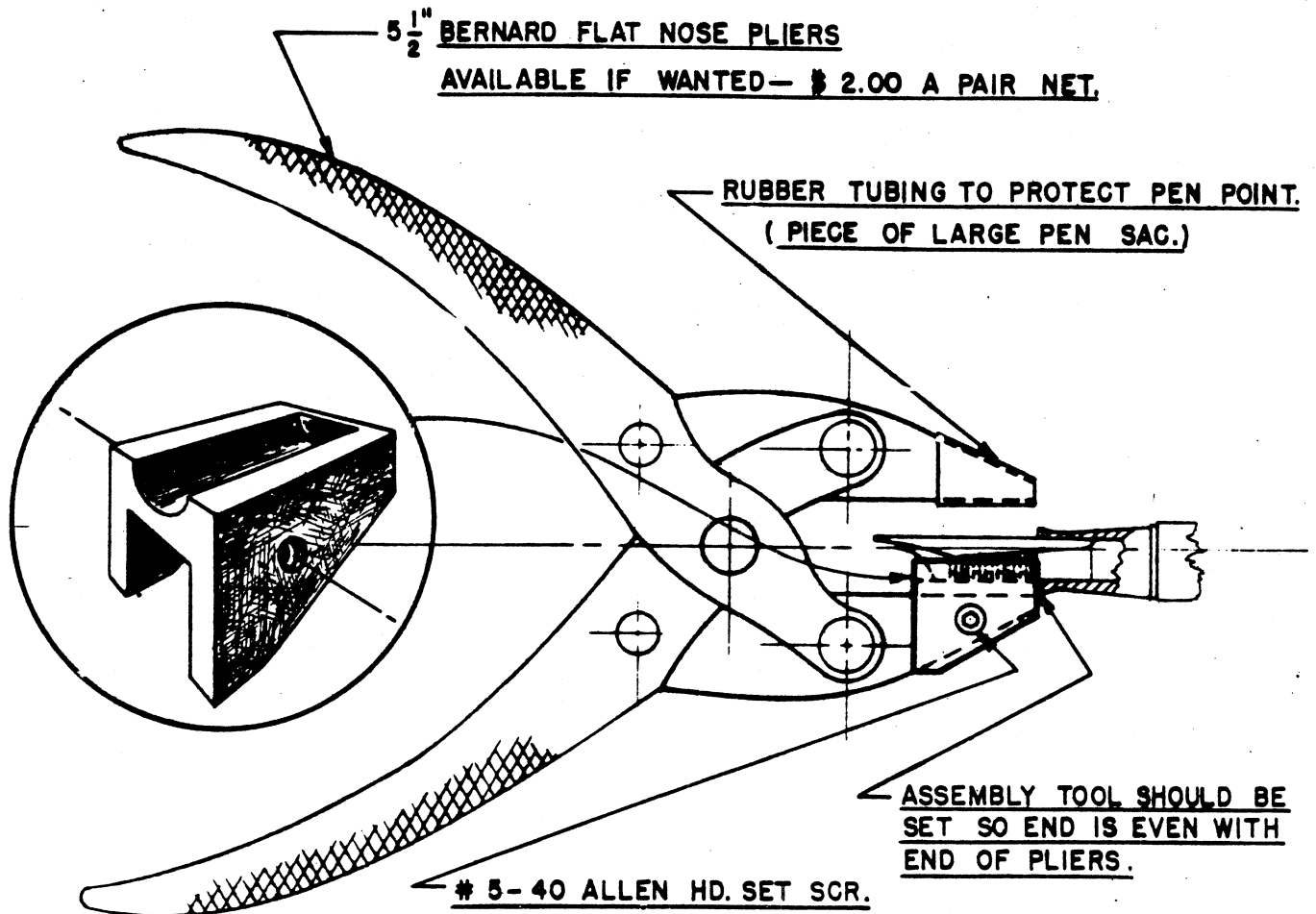

NOTE:

THE POINT & FEED ARE TO BE POSITIONED & STARTED INTO THE GRIPPING SECTION. THE FIN ON THE ASSEMBLY TOOL IS TO BE PLACED IN THE LAST COMB CUT IN FEED. THE POINT & FEED SHOULD THEN BE PUSHED INTO THE GRIPPING SECTION UNTIL NOSE OF PLIERS TOUCHES FACE OF SECTION.

SEEAFFER'S REPAIR SERVICE TOOLS AND SUPPLIES

<u>STOCK NO.</u>	<u>NOMENCLATURE</u>	<u>NET PRICE*</u>
1	Two Prong Bar Puller for 2T-2V-4T-8T	.50
1A	Solid Hook Bar Puller for 2-4-8 Two Piece Bar	.50
2	Bar Pusher for 8T	.80
3	Bar Pusher for 2T - 4T	.80
4	Bar Pusher for 2, 4, & 8 Two Piece Bars	.50
5	Lever Assembly Tool	1.00
6	Hooked Inner Cap Puller	1.00
7	Cap Thread Chaser .310-30	1.70
8	Barrel Thread Chaser .310-30	1.50
9	Vac Fill Plunger Removing Tool	.50
10	Vac Fill Plunger Lead	.40
11	Vac Fill Plunger Assembly Tool	.25
12	Vac Fill Lock Nut Wrench	.50
13	Tool for Removing Broken Point Holders	.75
14	Point Pushing Pliers & Attachment	4.25
14A	Point Pushing Attachment Only	2.25
15	"0" Ring Positioning Tool - Snorkel	.75
15A	"0" Ring Positioning Tool - TM	.75
15B	"0" Ring Positioning Tool - 920S	.75
16	Clip Spring Disassembling & Assembly Tool	1.25
17	Burnishing Tool	.75
18	V. Block for Sizing Pencil Mechanism	.25
19	Pin Vise	.75
20	Nib Pliers	1.75
21	Cutting Pliers	1.75
22	Needle Nose Pliers	2.25
23	Filler Tube Alignment Pliers	2.25
24	Gripping Section Tool - Snorkel	1.65
25	Tool for Removing and Assembling Ballpoint Mechanism & Assortment of Replacement Mechanisms	3.00
25A	Tool for Removing and Assembling Ballpoint Mechanisms (Tool Only)	2.00
26	Arbors for Removing Dents in Metal Caps - Snorkel - TM	2.50
26A	Arbors for Removing Dents in Metal Caps - #2 Size	2.50
26B	Arbors for Removing Dents in Metal Caps - #4 Size	2.50
26C	Arbors for Removing Dents in Metal Caps - #4.9 Size Pencils	2.50
26D	Arbor for Removing Dents in Metal Caps - #2 Size pencils	2.50
26E	Arbor for Removing Dents in Metal Caps - TP & Y9B Pencils	2.50
26F	Arbor for Removing Dents and tightening clips - Sheath type Cartridge pens	2.50
26G	Arbor for Removing Dents and Tightening Clips - Conventional Point Cartridge pens	2.50
27	Feed Broach - Snorkel Pens	.75
28	Eraser Pullers for Erasers Stuck in Caps	.35
29	Section Pliers	2.00
30	Feed Punches	.75
31	Sac Spreader	1.25
32	Point Holder Pliers Triumph	2.50
33	Drills for Fineline Pencil Tips .036	.35
34	Drill .050 for Large Pencil Tips	.35
35	Drills 5/16" for #2 Size Barrel Plugs	2.00
36	Drills 11/32" for #4 Size Barrel Plugs	2.00
37	Taps .311-36 for #79 & 92 Nib Units	5.50
38	Taps .311-40 for #93 Nib Units	5.50
40	Reamers .204 for #23-33 & 73 Sections	4.50
41	Reamers .234 for 5 & 74 Sections	4.50
42	Reamers .275 for #8 Sections	4.50
43	Point Push Gauge	2.25
44	Clip Spring Tool - Od Style	1.25

STOCK
NO.

NOMENCLATURE

NET
PRICE *

45	Clasp Spring Tool - Old Style	1.25
46	Inside Cutting Tool	1.00
51	Linen Tester (Point Magnifying Glass)	.50
52	Steel Rule 6 Inch	.25
53	Gold Wax for Filling Engravings	.10
54	Silver Wax for Filling Engravings	.10
55	Red Rouge for Polishing Sticks & Smoothing	.10
56	Bench Block for Disassembling Points & Feeds	.75
57	Burnishing Blocks for Ironing Bent Points	4.00
58	Bench Hammer - Steel Head	1.00
59	Rubber Bulbs	.15
60	Blank Files for Hand Turning Tools	.25
61	Alcohol Lamps	.50
62	Polishing Stick	.25
63	Finger Cot	.10
64	Thread Seal 5/8 Oz. (Rosin & Castor Oil)	.25
64A	Thread Seal, 1 Pint (Rosin & Castor Oil)	.75
65	Polishing Cloth	.75
66	Rosin, Lead Tube	.50
67	Cleaning Powder for Points & Feeds (Trisodium Phosphate)	.25
68	Arabol Cement, 5/8 Oz.	.25
68A	Arabol Cement, 1 Pint	1.25
69	EC 847 Cement 5/8 Oz.	.25
69A	EC 849 Cement, 1 Quart	2.00
70	MC Thinner 5/8 Oz.	.25
70A	MC Thinner, 1 Quart	1.25
71	Shellac, 5/8 Oz.	.25
71A	Shellac, 1 Pint	1.75
72	Rosin Flux, 5/8 Oz.	.25
74	Rubber Hose	.25
75	Plastic Hammer	1.25
82	Door Ease	.25
83	Burnisher for Ironing Bent Points	1.25
84	Polish, 1/4 Bar for Polishing Holders	.50
85	Smoothing Paper (3 x 4" per sheet)	.05
86	Spiral Brush	.25
87	Oakite Cleaning Powder for Caps & Barrels, 1 lb.	.50
88	Hand Turning Tool	.60
89	Pierce Tube Assembly Tool - Sheath Type and Conventional Cartridge Pens	1.50
90	Arbor for Tightening clips and sizing barrel mouths - All-Metal Ballpoints	1.60
91	Threaded Puller for Inner Liner	.45
92	Arbor for Removing Dents in Metal Barrels - Lady Sheaffer	2.50
93	EC 524, Nameplate cement, 5/8 oz.	.25
94	Glycerine, 5/8 oz.	.25
95	Petrolatum, 5/8 oz.	.25
96	Spermaceti and Castor Oil, 5/8 oz.	.25
97	DPR Solution, 5/8 oz.	.25
98	Plastic Thread Shield for Skripsert Pens	.15
99	Threaded Bushing Tool - PFM	1.65
100	Compression Gasket Positioning Tool - PFM	.75
101	Plastic Thread Shield for Compact Pens	.15
102	Retainer Inner Sleeve Assembling & Disassembling Tool - Reminder Clip Ballpoint	2.50
103	Clip Spring Assembling & Disassembling Tool - Reminder Clip Ballpoint	2.75

* Prices are subject to change without notice.

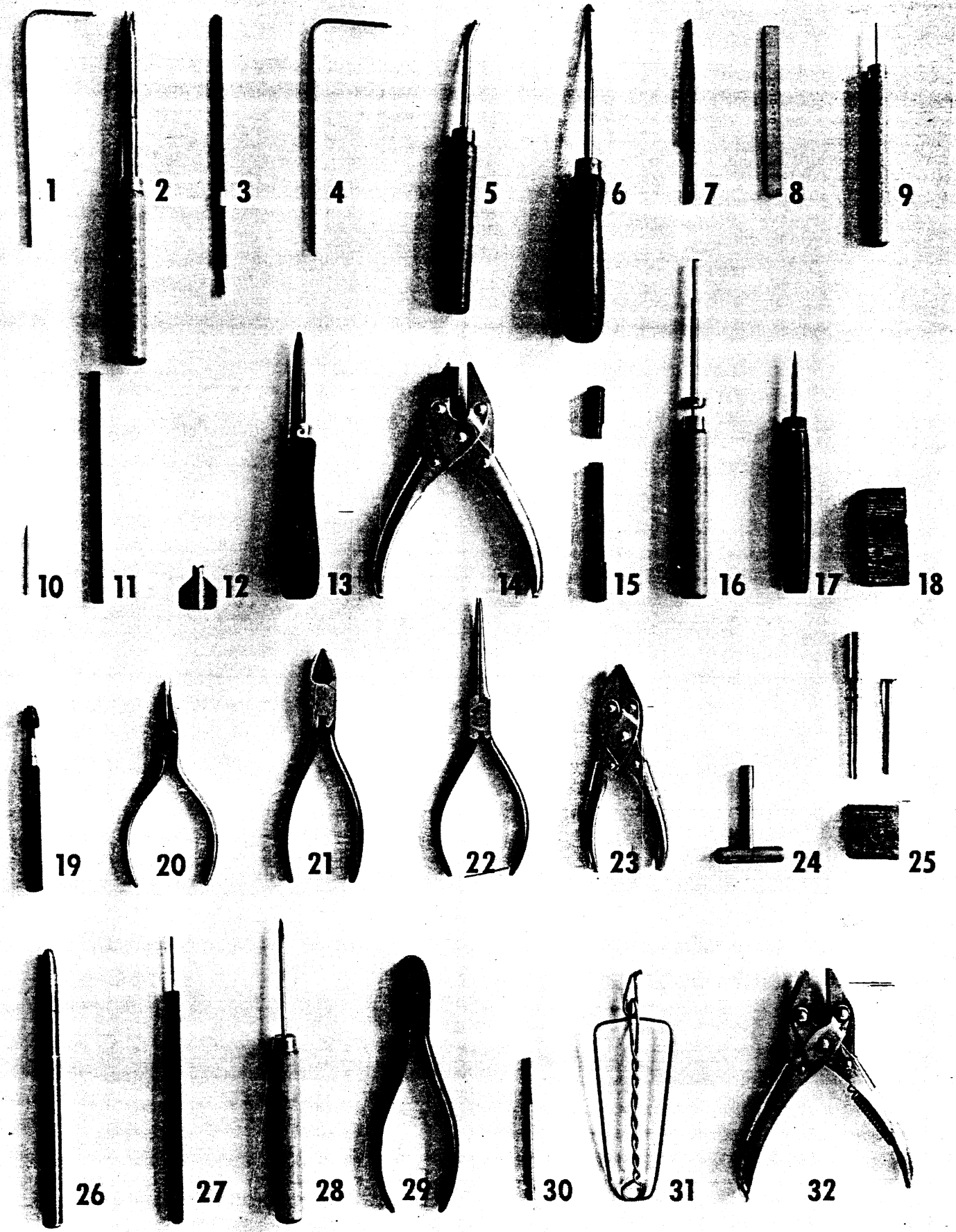

MECHANISM REPLACEMENT TOOL SET

CLICKER BALLPOINT PENS

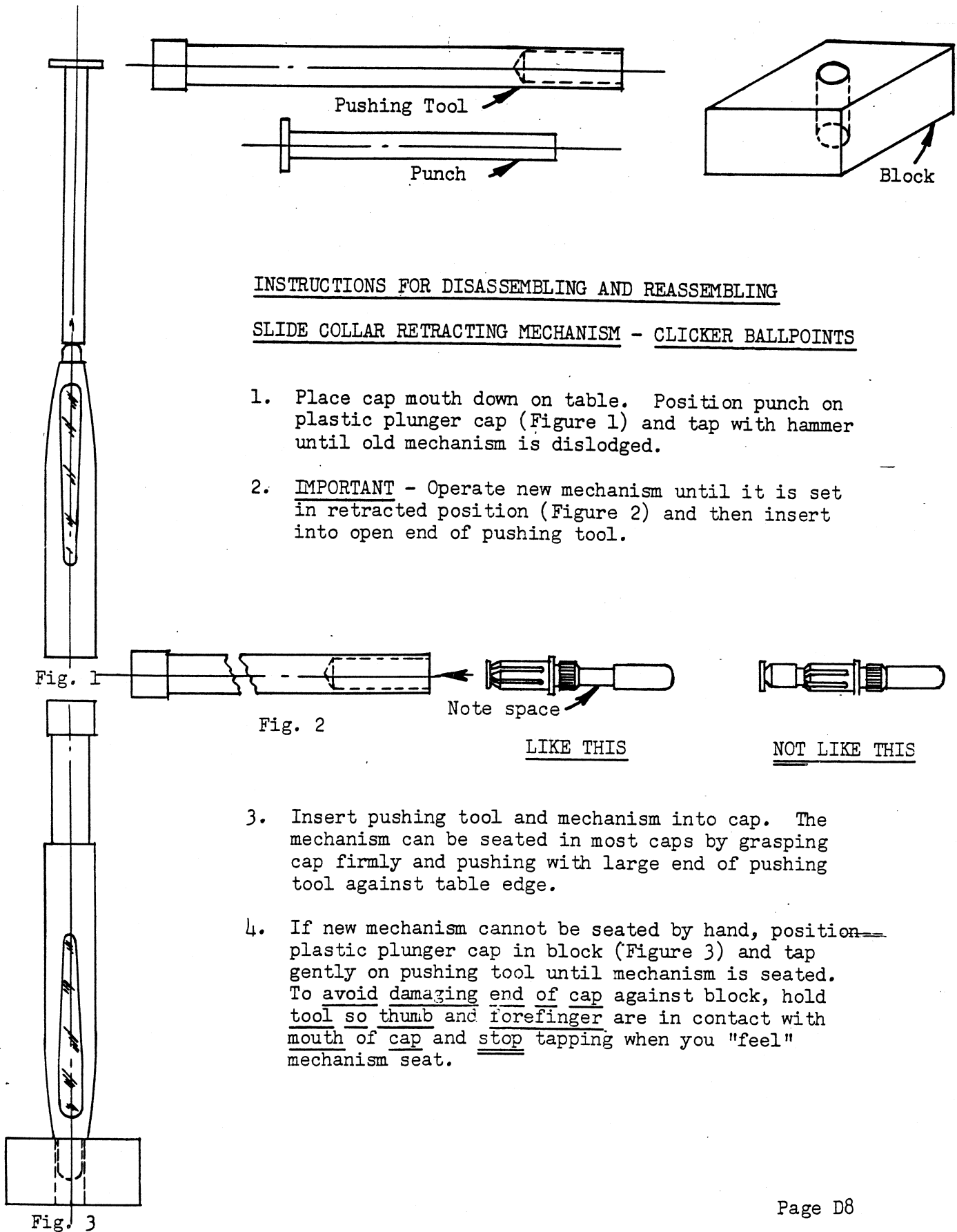

INSTRUCTIONS FOR DISASSEMBLING AND REASSEMBLING

SLIDE COLLAR RETRACTING MECHANISM - CLICKER BALLPOINTS

1. Place cap mouth down on table. Position punch on plastic plunger cap (Figure 1) and tap with hammer until old mechanism is dislodged.
2. IMPORTANT - Operate new mechanism until it is set in retracted position (Figure 2) and then insert into open end of pushing tool.

3. Insert pushing tool and mechanism into cap. The mechanism can be seated in most caps by grasping cap firmly and pushing with large end of pushing tool against table edge.
4. If new mechanism cannot be seated by hand, position plastic plunger cap in block (Figure 3) and tap gently on pushing tool until mechanism is seated. To avoid damaging end of cap against block, hold so thumb and forefinger are in contact with mouth of cap and stop tapping when you "feel" mechanism seat.

GRIPPING SECTION TOOL

SNORKEL PEN

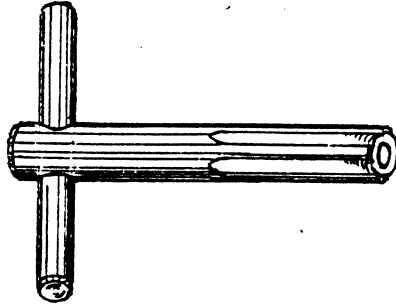

This tool is for removing the threaded portion of the gripping section that remains in the Snorkel Pen barrel in case a gripping section becomes broken.

INSTRUCTIONS FOR USE

1. Leave the filler tube assembled in the sac bushing. The tool has a hole which will accommodate the tube.
2. Line splines in sac protector up with splines in threaded piece and retract filler tube by turning plunger knob to right in the regular manner. (Remember - some will have a large spline.) This will pull sac protector down through threaded piece so that tool can engage in threaded piece.

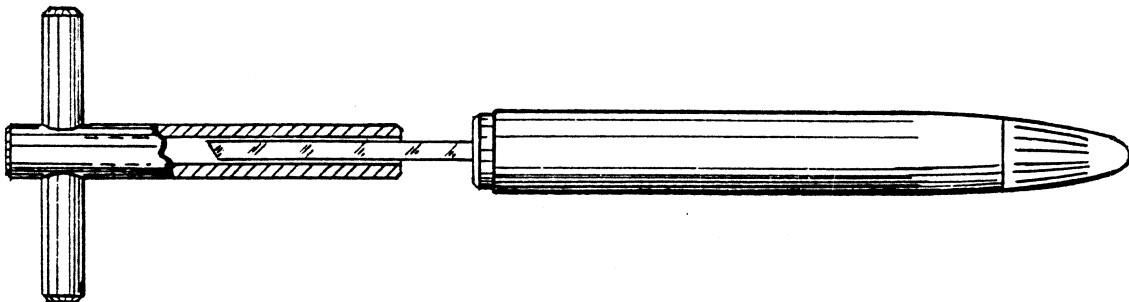

3. Position tool with filler tube in hole and engage splines on tool with splines on threaded piece.
4. Turn tool to left to unscrew threaded piece and allow the plunger knob to unscrew. As the threaded piece is unscrewed push in on tool to keep maximum engagement and not allow propelling spring to push sac protector out and disengage tool.

FEED BROACH

SNORKEL PEN

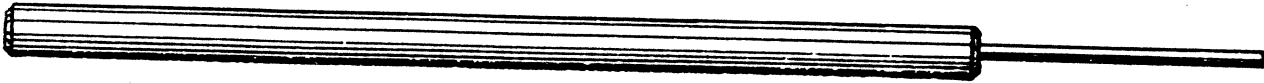

This tool is to be used for removing binds in Snorkel pen filling tube action.

INSTRUCTIONS FOR USE

This filler tube should extend from the pressure of the propelling spring. It should retract smoothly and easily. If there is a bind in the action and inspection reveals that the splines on the sac protector do not bind or are mismatched with the splines in the gripping section, the difficulty may be in the fit between the filler tube and the feed.

1. Remove point unit from gripping section.
2. Insert feed broach into hole in feed from the back of the unit.

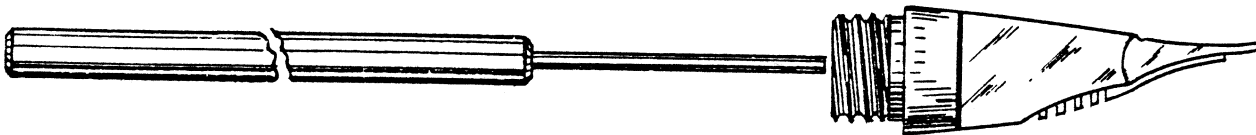

3. Press cutting edge of broach against side of hole on the long or finger side of the feed and push broach forward through feed. Be sure and blow all shavings out of feed.
4. Try fit and repeat above as necessary.
5. If broaching the hole in the feed does not correct the binding, check the fit of the point holder gasket on filler tube. If the gasket is tight, lubricate filler tube with petrolatum. C A U T I O N: Apply petrolatum on that part of filler tube that is on barrel side of gasket and never on portion that enters feed.

ERASER PULLER

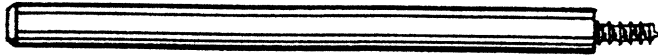

This tool is to be used for removing erasers that may become stuck in pencil caps.

INSTRUCTIONS FOR USE

All Sheaffer pencil caps have ample clearance for the eraser however, sometimes the eraser comes out of the mechanism and becomes lodged in the cap, so that the mechanism with a new eraser will not fit. The old eraser can easily be removed with this tool:

1. Insert Threaded end into pencil cap.
2. Start thread in the small hole in the eraser cup and turn engaging the threads in the hole.



3. Pull out the old eraser after the threads engage in the hole.
4. If the eraser has no metal cup the threads will engage in the rubber like a cork screw so the tool may also be used on this type of eraser.

PIERCE TUBE ASSEMBLY TOOL #89

CARTRIDGE PENS

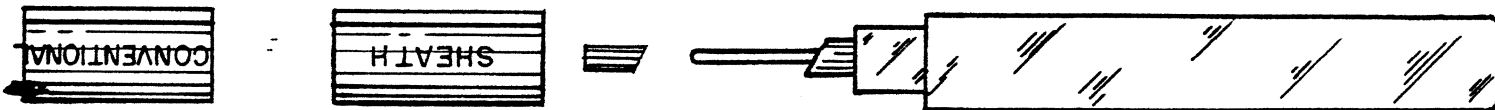

This tool is for assembling the pierce tube into the gripping section or threaded pushing. It is designed for use with either the conventional point cartridge pen or the sheath point cartridge pen.

INSTRUCTIONS FOR USE

1. Place pierce tube on pilot rod with angle against the angle on the tool. The longer edge of the pierce tube is sharp so it will pierce the plastic strip cartridge. By properly placing the tube on the angle this sharp edge will be positioned over the secondary angle on the tool thus not dulling the edge.
2. Position the correct brass spacer (conventional or sheath) on the trunion of the tool.



3. The longer portion of the pierce tube should be aligned with the point. This is done by lining the flat on the handle with the point (this flat is correctly aligned with the angle). Insert the pilot into the pierce tube hole in the gripping section (conventional point type) or the thread pushing (sheath point type) and push until the spacer rests against the shoulder on the gripping section. It may be necessary to place the gripping section point down in a Bench Block for Disassembling Points and Feeds (#56) and tap gently on the handle of the tool to drive the pierce tube into the hole.
4. Remove the tool and the spacer from the tool. Run the pilot back and forth through the pierce tube to loosen any burr that the pierce tube may have pushed up. Remove the tool and tap the assembly with pierce tube down several times to shake any burrs out.

Complete repair instructions for cartridge pens on pages C11, C12, and C13.

ARBOR FOR TIGHTENING CLIPS AND
SIZING BARREL MOUTHS #90

ALL-METAL BALLPOINT PENS

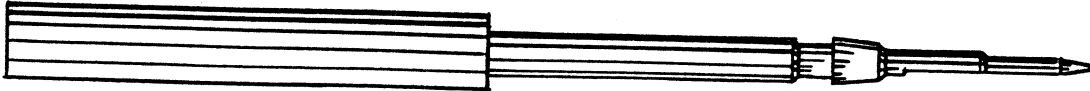

This is a combination tool that can be used for tightening the clips in all-metal retractable ballpoint pens or opening up the mouths of the barrels on the all-metal ballpoints that have been bent.

INSTRUCTIONS FOR USE

TIGHTEN CLIPS:

1. Remove the retracting mechanism as described on manual page D8.
2. Insert arbor into cap holding the arbor against one side of the cap. A definite "click" will be felt when the anvil area of the arbor clears the inner sleeve and is under the clip ears.
3. Place the end of the arbor on a table, flattened area directly under the clip ears. Hold the cap forward slightly so the end of the inner sleeve will be against the edge of the anvil area.

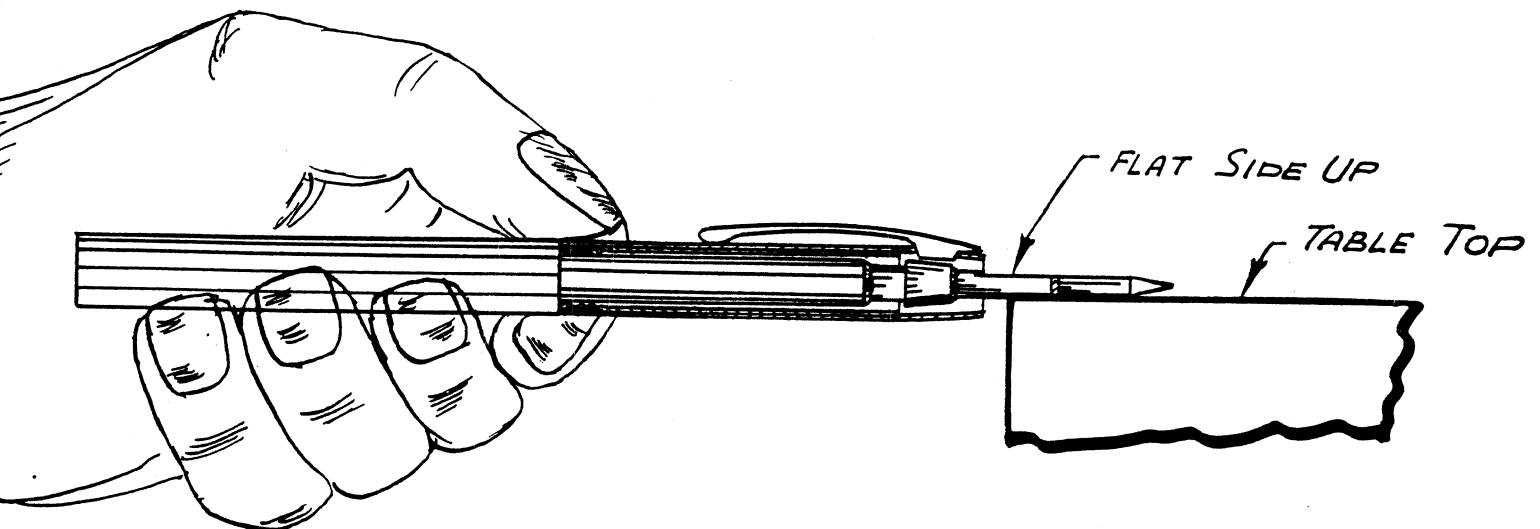

4. Tap the clip over the ears sharply with a plastic hammer (#75) so that the anvil area will cause the clip ears to clinch.
5. Remove arbor and assemble retracting mechanism with assembly tool (#25) modified as described on page C14.

SIZE BARREL MOUTH:

When a pen has been dropped causing the mouth to distort so the unit will not extend through, the mouth can be opened to the correct size by inserting the pointed arbor into the barrel and forcing it through the mouth.

PART EXCHANGE POLICY

This policy is to be used only for the sole purpose of adjusting parts stocks to be used on repairs. The company reserves the right to refuse to handle shipments not judged to be in this category.

1. Any used lifetime cap can be exchanged for any other available cap on a dollar-for-dollar value basis for the lifetime exchange charge.*
2. Any used lifetime point can be exchanged for any other available point on a dollar-for-dollar value basis for the lifetime exchange charge.*
3. Any used lifetime barrel can be exchanged for any other available barrel on a dollar-for-dollar value basis for the lifetime exchange charge.*
4. Any other used lifetime small part can be exchanged for any other available comparable small part on a dollar-for-dollar basis for the exchange charge.*
5. Any used non-lifetime point can be exchanged for any other available non-lifetime point on a dollar-for-dollar basis for the non-lifetime exchange charge.*
6. Any used non-lifetime barrel can be exchanged for any other available non-lifetime barrel on a dollar-for-dollar basis for the non-lifetime exchange charge.*
7. Any used non-lifetime small part can be exchanged for any other non-lifetime available comparable small part on a dollar-for-dollar basis for the exchange charge.*
8. Any used non-lifetime all metal or 1/4 Kt. trimmed pen or pencil cap will be exchanged for the used cap exchange charge. Other non-lifetime used pen, pencil, or ballpoint caps have no exchange value. Any new non-lifetime caps, plastic or metal, pen, pencil, or ballpoint, can be exchanged for any other available non-lifetime cap on a dollar-for-dollar basis. The charge for exchange will be 35¢ on Craftsman and Admiral pens - 40¢ on all other pens and 25¢ on pencils and ballpoint caps. Any cap with scars, mars, scratches, dents, or ink stains will be considered used.
9. This policy does not apply to 1/4 Kt. Masterpiece pen, pencil, or ballpoint caps and barrels.

* We will supply in dollar value an equal amount of parts in exchange for the same value of used parts. When there is a difference in value, the part returned is of greater value than the part desired, an additional part must be supplied with the additional charge being billed at net. No credit will be issued. (See example sheet attached)

By using this new policy you can control your over-stock and understock condition by always requesting in exchange for over-stock parts, that we return parts on which you are under-stocked. Any over-stock condition should work itself out in due time in this manner. However, if you find it necessary to return new parts, not being able to adjust your stock by returning used parts, the same exchange charges (used parts exchange charges on attached sheet) will apply.

Attached is a copy of our exchange charges and an example sheet showing you how the new policy can be used and how charges will be figured. We believe this addition to our present policy will be mutually advantageous.

W. A. SHEAFFER PEN COMPANY

PARTS RETURNED

PARTS WANTED IN EXCHANGE

METHOD OF COMPUTATION

COST SERVICE CHARGE & NET BILLING

6 old style #8 lever barrels

Snorkel barrels

6 #8 bbls. @ \$2.60 = \$15.60 list
 6 Snorkel bbls @ \$3.00 = \$18.00 list
 Bill 2.40 list

Service charge on 6 lifetime barrels @ .05 = .30 net
 Billing for difference on extra barrel - \$2.40 list or \$1.20 net
 Total for exchange, \$1.50 net

24 assorted - 93 Lifetime & 92 Lifetime points

12 Snorkel points

24 assorted #93 & 92 Lft. points @ \$6.00 = \$144.00 list
 21 #12 Snorkel pts. @ \$7.00 = \$147.00 list
 Bill 3.00 list

Service charge on 24 lifetime points @ 10¢ each = \$2.40 net
 Billing for difference on pt \$3.00 list or \$1.50 net
 Total for exchange, \$3.90 net

18 assorted plungers

TM Plunger & Protector Tubes

18 Plungers @ .60 = \$10.80 list
 27 TM Plunger & Protector Tubes @ .40 = \$10.80 list

Service charge on 18 plungers @ 10¢ ea. = \$1.80 net

4 Assorted #12 TM barrels

Craftsman barrels

4 TM bbls. @ \$2.60 = \$10.40 list
 9 Craftsman bbls. @ \$1.25 = 11.25 list
 Bill85 list

Service charge on 4 #12 TM bbls. @ .40 = \$1.60 net
 Billing for difference on extra bbl. - 85¢ list or 42¢ net
 Total for exchange, \$2.02 net

CONSOLIDATED PARTS EXCHANGE PRICES

These sheets condense all Parts Exchange Prices for your convenience. Prices apply to used parts accumulated from repair work and to new parts returned to adjust parts stocks in accordance with Parts Exchange Policy explained on Page D9, D10 and D11.

Net Exchange Price

PEN PARTS, MODELS WITH LIFETIME POINTS:

Point or Point Units	.10	Cap	.10	Assembled Barrels	.05
----------------------	-----	-----	-----	-------------------	-----

PEN PARTS, MODELS WITHOUT LIFETIME POINTS INCLUDING CURRENT LINES:

Net Exchange Price

Points, Conv.:		Caps, Pre-Snorkel & Snorkel:	
Stainless Steel	No Exchange	Sovereign	1.55
#23, 3, 33	.35	Sentinel-Clipper	2.10
#5, 52, 5SK, 6SK	.40	Crest-Triumph	2.45
#73, 74, 74SK	.45	Signature	3.35
#8	.50	Autograph	5.05
Points, Sheath:		Snorkel Autograph (new)	3.60
C8W, C9W	.60	Masterpiece-Crest Masterpiece	13.20

Point Units:		Other Barrels:	
Stainless Steel	No Exchange	Lady Sheaffer I - XIV	1.00
Sheath Type, 14Kt Gold	No Exchange	Lady Sheaffer XV - XVII	2.00
and Palladium Silver	.75	Lady Sheaffer XX - XXI	2.50
Points & Gripping Sections:		Lady Sheaffer XXIII - XXIV	4.00
#14PFM, 15PFM	.60	Lady Sheaffer XXXV	4.75
AS17, ASD17, AC21, ACD21,	.60	PFM I, II, III	2.00
AC20, & ACD20	.60	PFM IV, V, Autograph	2.10
Writing Units:		Imperial III, IV, VI	2.45
#12 & 13SK	1.25	Compact I, II	4.00
#33, 52, 73, 74, 8, 10, 12 TD	1.00	Desk Pens with Quill:	2.10

Writing Units:		CD, Black	.35
#12 & 13SK	1.25	CD, Colored	.45
#33, 52, 73, 74, 8, 10, 12 TD	1.00	55SD	.45
Parts Related to Points:		20FD, 92SD	.50
Feeds	.10	Snorkel	.40
Feed Inserts	No Exchange	Imperial	.90
Filler Tubes & Inserts, 121SK	.30	Compact	.60
Filler Tubes & Inserts, 5SK, 74SK, 25	.05	Lady Sheaffer	1.75
Filler Tube Inserts	No Exchange	Parts Related to Pen Barrels:	
Pierce Tubes	.10	Barrel Shells, Plastic, Touchdown	.10
Point Holders	.02	(with Plunger Knob)	.10
Point Holder Gaskets	No Exchange	Barrel Shells Plastic, 202F,	
Seal Gasket Washers	No Exchange	Snorkel PFM, Imperial (No	
		Plunger Knob)	.10

SUBSTITUTION POLICY

This policy is provided so you can identify the models on the Factory Substitution List. It should be used when obsolete models are brought into your shop. It not only identifies models on the Substitution List but also specifies which model should be made up and the price.

Substitutions are necessary for many reasons. In most cases the materials from which older repair parts are made are no longer available. There has been a great swing to molded parts in recent years, not only in the pen industry but in general, consequently, our suppliers no longer make flat, rod or tube stock. In fact, some of the suppliers are no longer in business.

To further complicate this problem, the plastic materials, the very best available at the time, tend to become brittle with age and shrink and fade. To correctly recondition a pen it must be dismantled and, during the process, even with the greatest of care, the brittle or shrunken parts may break. When we must replace a part, the parts will not fit or work well together due to shrinkage and will not match other parts due to fading.

To meet these problems we inaugurated our Substitution Program. This program is specifically designed so as to be to the advantage of the customer. We offer very generous trade in allowances, as high as 70% of the original price, on models 10, 20, 30 years old or older. If, for some reasons of sentimental attachment, the customer does not want to take advantage of this startling offer we will repair the old pen if it is a guaranteed model. These substitution pens are all black to avoid color matching problems in the future.

These advantages should be pointed out:

1. The substitution pen is a brand new pen of equal, or more, value than the old pen.
2. It has the one stroke modern touchdown filler, sure grip inner spring clip, better fluid control and modern design.
3. It will closely match the size and shape of the old pen.
4. The point will be of the same style and the customer can choose the point grade.
5. We no longer make Lifetime pens, however, the new pen will be serviced at a very nominal fee.
6. We will also exchange the pencil.
7. If the customer does not accept the offer we will repair the old one if it is a guaranteed model.

As a repair station you have these advantages:

1. The substitution pen is pre-snorkel. You will want to try to interest your customer in a new snorkel first.
2. You can make the substitution in your own shop for the prices shown on pages D18 and D19. The old pen should be dismantled and identified and sent in for parts exchange. These parts will be exchanged for the low exchange prices. As an example, in the case of a substitution on the Lifetime 93WH you receive \$3.50 from your customer and receive back replacement parts for only 25¢.

Remember, this program is definitely to your advantage. It is also definitely to the customers advantage and made available by us at such tempting prices only as a reward for our customers loyalty and because of our desire to provide good service, at any expense. Please cooperate and use the program as it is intended.

HOW TO USE THIS LIST

For Lifetime Models Only:

1. Determine if the pen is on the Substitution List. Outline drawings are provided on pages D16 and D17 to help identify all models on the Substitution List.
2. Using the number at the left, find the group the number is in on page D18. This page will change from time to time.
3. From the columns at the right determine the substitution model and price.
4. Inform your customer of the substitution offer using the sales outline on page D14.
5. If the customer accepts, make up the model with the correct parts. Don't forget to ask customer what grade of point he wants in the new pen.
6. Dismantle old parts and send in together for exchange. Identify the parts and we will exchange them for parts to make up the substitution model to replenish your stock. This will be done for the parts exchange charge.

For Non-Lifetime Models (#3-#23-#33-#5-#55 points)

The following models are substituted in all colors: Models and Prices on Page D19.

All flat end models (made prior to 1930)

All mottled and black balance models (made prior to 1930)

All striated and black models with solid or visulated gripping sections that are not chased (made prior to 1945)

The following models are repaired:

All striated and black models with visulated gripping sections that are chased.

All Touchdown Models - All Snorkel Models.

All Tip-Dip Models - All Skripsert Models.

COLOR CODE EXPLANATION

- L - Black
- A - Black and gray mottled with lines of red.
- K - Green and white mottled.
- H - Green and black mottled.
- J - Green and white mottled.
- D - Black and pearl mottled with red and green highlights in pearl.
- C - Brown and black striped.
- E - Green and black striped.
- F - Rose and black striped.
- P - Gray and black striped.
- S - Carmine and black striped.

Pencil Substitution List on page D19.

Pencil must be traded in to qualify for substitution price.

WHITE DOT MODELS

Plastic Cap - #73 Points

- 1. 73V - Lever fill.
- 2. 73WS - Vac fill.

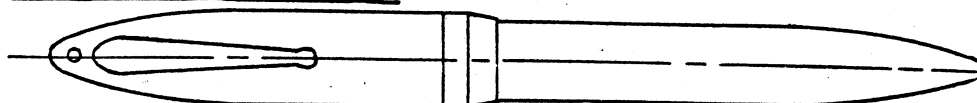

- 3. 73H - Lever fill.
- 4. 73WH - Vac fill.

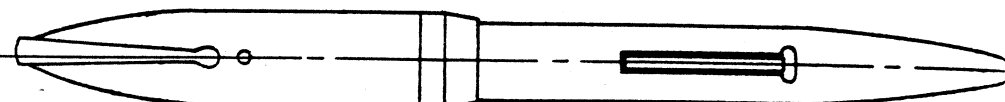

- 5. 73T - Lever fill.
- 6. 73W - Vac fill.



- 7. 735WS - Same size as 73WS - Vac fill - Autograph band.
- 8. 735V - Same size as 73V - Lever fill - Autograph band.

Plastic Cap - #74 Points

- 9. 74SC - Lever fill.

- 10. 74SR - Lever fill - Ring in cap - No clip.

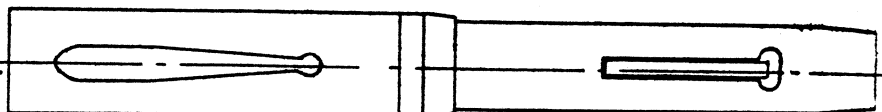

- 11. 74AC - Same size as 74SC with balance cap and flat end barrel.
- 12. 74AR - Same size as 74SR with balance cap with ring and flat end barrel.
- 13. 743T - Same size as 73T - Lever fill.

- 14. 74T - Lever fill.

- 15. 74W - Vac fill.

- 16. 74TR - Same size as 74T ring in cap - no clip - Lever fill.
- 17. 74TCD - Same as 74T with quill on end of barrel - Lever fill.
- 18. 74P - Same as 74T with pencil on barrel - Lever fill.

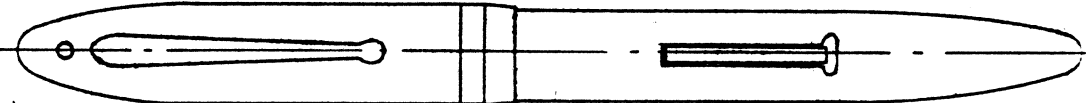

- 19. 74H - Lever fill.

- 20. 74WH - Vac fill.

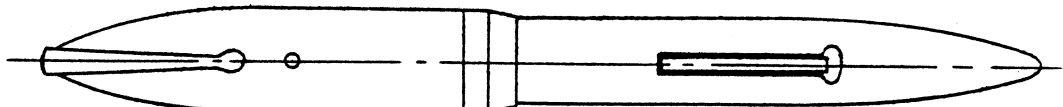

- 21. 74V - Lever fill.

- 22. 74VR - Lever fill - Ring in cap - No clip.

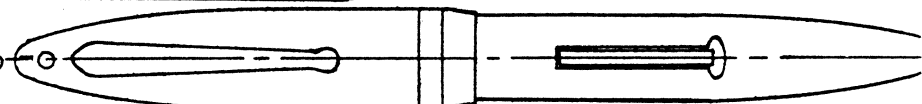

- 23. 74MC - Smaller than 73V - Lever fill.
- 24. 74MR - Smaller than 73V - Ring in cap - Lever fill.
- 25. 75T - 76T - Same size as 74T - Lever fill - Autograph band.
- 26. 75W - 76W - Same size as 74W - Vac fill - Autograph band.

Plastic Cap - #8 Points

- 27. 8T - Lever fill.

- 28. 8W - Vac fill.

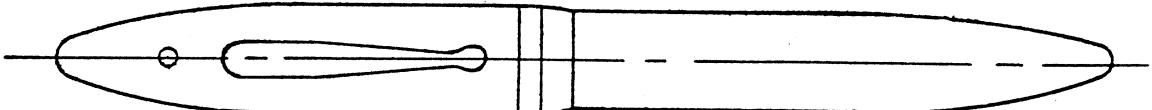

- 29. 8TR - Same size as 8T - Ring in cap - No clip - Lever fill.

- 30. 8C - Lever fill.



- 31. T8C - Same length as 8C - Flat end - Smaller diameter - Lever fill.
- 32. 8AC - Same size as 8C - with balance cap and flat end barrel - Lever fill.
- 33. 8AR - Same size as 8C - with balance cap with ring and flat end barrel - Lever fill.
- 34. T8SC - Same size as 74SC - flat end - Lever fill.
- 35. T8SR - Same size as 74SC - Flat end - Ring in cap - Lever fill.
- 36. T89C - 89C - 85C - T85C - Same length as 8C - Flat end - Varying diameters - Autograph bands - Lever fill.
- 37. T85SC - Same size as 74SC - Autograph band - Lever fill.
- 38. 85T - 86T - Same size as 8T - Autograph band - Lever fill.
- 39. 85W - Same size as 8T - Autograph band - Vac fill.

WHITE DOT MODELS

Plastic Cap - Sheath Points

- 40. 93H - Lever fill.
- 41. 93WH - Vac fill.

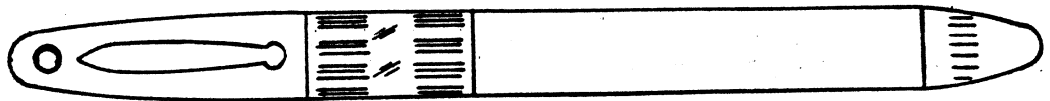

- 42. 93WM - Vac fill.



- 43. 93H Auto - Same size as 93H - Autograph band.
- 44. 93WH Auto - Same size as 93WH - Autograph band.
- 45. 93WM Auto - Same size as 93WM - Autograph band.

Metal Cap - #73 Points

- 46. 46A - Gold filled cap and barrel - Lever fill.
- 47. 46AW - Gold filled cap and barrel - Vac fill.
- 48. 446A - Same size as 46A - 14 Kt. gold cap and barrel - Lever fill.

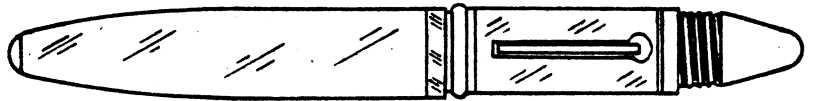

- 49. 26V - Gold filled cap - Lever fill.
- 50. 26WS - Gold filled cap - Vac fill.

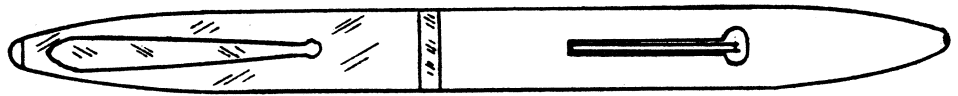

- 51. 266V - Same size as 26V - 14 Kt. gold cap - Lever fill.
- 52. 7336TC - Same size as 47T - 14 Kt. gold cap and barrel - Lever fill.

Metal Cap - #74 Points

- 53. 47T - Gold filled cap - Lever fill.
- 54. 47W - Gold filled cap - Vac fill.
- 55. 476T - Same size as 47T - 14 Kt. gold cap - Lever fill.

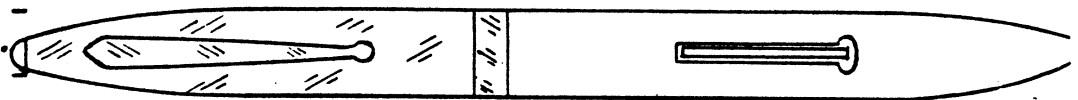

Metal Cap - Sheath Points

- 56. 49T - Gold filled cap - Lever fill.
- 57. 49W - Gold filled cap - Vac fill.
- 58. 49WM - Gold filled cap - Vac fill.
- 59. 497W - Same size as 49T - 14 Kt. gold cap - Vac fill.
- 60. 9337T - Same size as 49T - 14 Kt. gold cap and barrel.

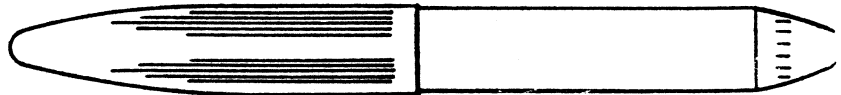
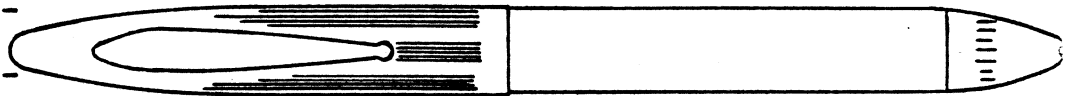

Desk Pens and Sockets - #74 Points

- 61. 74D - 74DP - 74DG - Lever Fill. Socket and Post also substituted to match pen.

Desk Pens and Sockets - Sheath Points

- 62. C92WD - Vac Fill. Socket and Post also substituted to match pen.

WHITE DOT MODELS

Key	Symbol No.	Substitution Model:			Price	Key No.	Symbol No.	Substitution Model:			Price
		Cap	Barrel	Nib				Cap	Barrel	Nib	
1	73V					43	93				
2	73WS					44	93WH Auto	121S	121S	121S	\$6.50##
3	73H	121S	121S*	73SH	\$3.00#	45	93WM Auto	Auto			
4	73WH					46	46A	37WM	82SM*	73SH	3.50##
5	73T					47	47AW				
6	73W										
7	735WS					48	This substitution made at factory only			10.00##	
8	735V	121S-6	121S*	73SH	4.50##						
9	74SC					49	26V				
10	74SR					50	26WS	112S	112S*	73SH	3.50##
11	74AC										
12	74AR					51	This substitution made at factory only			10.00##	
13	74ST					52	This substitution made at factory only			15.00##	
14	74T					53	47T	112S	121S**	74SH	3.50##
15	74W	121S	121S**	74SH	3.00#	54	47W				
16	74TR					55	This substitution made at factory only			10.00##	
17	74TCD					56	49T	112S	121S	121S	5.00##
18	74P					57	49W				
19	74H					58	49WM				
20	74WH										
21	74V					59	This substitution made at factory only			10.00##	
22	74VR					60	This substitution made at factory only			17.00##	
23	74MC					61	74D-74DP	79D Skt	92SD***	74SH	3.00#
24	74MR					62	C92WD	79D Skt	92SD	92SH	3.50#
25	75T-76T	121S-6	121S**	74SH	4.50##						
26	75W-76W										
27	8T										
28	8W										
29	8TR	Choice of:									
30	8C										
31	T8C-84C	1) 920S	82S	8SH	3.00#						
32	8AC	2) 8T	8T	8SH	3.00#						
33	8AR	-(For those who like the larger size.)									
34	T8SC										
35	T8SR										
36	T89C-89C	Choice of:									
37	T85SC	1) 920S	82S	8SH	6.50##						
38	85T-86T	Auto									
39	85W	2) 8T	8T	8SH	6.50##						
		Auto	(For those who like the larger size.)								
40	93WH										
41	93WH	121S	121S	121S	3.50#						
42	93WH										

* Fitted with 73S barrel end.
 ** Fitted with 74S barrel end.
 *** Fitted with 55SD barrel end.
 # Plus 10% Manufacturers Excise Tax (When exchanged at factory)
 ## Plus 10% Federal Retailers Excise Tax

PENCILS MATCHING LIFETIME MODELS			
Price	Substitution Model	Cap	33S
		Barrel	33S
\$ 2.50#			Use customers point if ok, if not use #33
3.00#		52S	Use customers point if ok, if not use #52
3.00#		55SD holder with 33SD or 55SD section - 79D skt #52	Use customers point if ok, if not use #33 or #52
			All Desk Pens with #3 or #5 Points
		52S	All Pens with #53 - #5.30 - #5 - #55 Points
		33S	All Pens with #22 - #23 - #3 - #33 Points

PENCILS MATCHING SUBSTITUTED NON-LIFETIME MODELS			
Price	Substitution Model	Cap	LH40
		Barrel	LH40
\$ 1.50#			ALL Plastic - Gold-Filled Bands
3.00#		LH40-6	ALL Plastic - LKt Signature Band
4.50#		LH40-Auto	ALL Plastic - LKt Autograph Band
2.50#		LH6	Gold Filled - Plastic Barrel
9.00#			LKt Cap - Plastic Barrel
12.00#			LKt Cap - Barrel
			This substitution made at factory only

PENCILS MATCHING SUBSTITUTED NON-LIFETIME MODELS			
Price	Substitution Model	Cap	H3
		Barrel	H3
2.50#			Models
			Pencils to match pens with #2 - #22 - #23 - #3 - #33 Points
2.75#		H5	Pencils to match pens with #53 - #5.30 - #5 - #55 Points
			Balance

Plus 10% Manufacturers Excise Tax. (When exchanged at factory)
 # Plus 10% Federal Retailers Excise Tax.

3/1/60

REPAIR INSTRUCTIONS

The list price of the C8W point has been reduced from \$2.75 to \$2.25. The exchange price remains at .60. Please make this correction on pages B45 and B51.

SPECIAL TECHNICAL INFORMATION

The C8W point is now being made slightly thicker, therefore, the feed is being made thinner. Since this difference is not detectable to the eye, a special marking has been placed on both feeds and points as illustrated below. This change was made necessary by the manufacturing process only and the old points are still completely satisfactory for use on old or new pens as long as the correct feed is used. Conversely, the newer point will assemble with the older pens as long as the correct feed is used.

OLD STYLE FEED & POINT

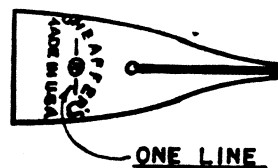
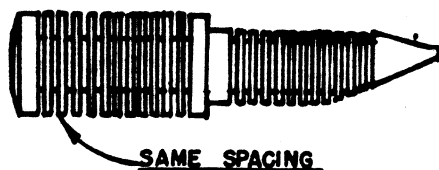

NEW STYLE FEED & POINT

